

# Unitech Screw Pumps Series 310 Models PV310M2MR

## APPLICATION:

These pumps have the ability of a delicate straight-streaming transport of a wide range of liquids with or without solid fragments with viscosity up to 150 Pa.s. These pumps suck from depth up to 6 meters under their own level. Their construction allows reversible depending on the direction of the electric motor.



## STANDARD EQUIPMENT:

Material AISI 304/ NBR  
Standard Inlet / Outlet: male union joints DIN 11851  
**\*M2-modification** (Geared body for direct joining with standard el. motor mounted on frame)  
**\*Mr-modification** (Gear-motor)

## OPTIONS:

**\*K-modification** (mounted on a trolley with Starter)  
**\*B-modification** (By-pass with safety overflow valve)  
**\*Inverter** – Electrical variable speed  
**\*Fr** –Protective dry run  
Material AISI 316  
Connection: Garolla, SMS, Macon, Clamp, etc.  
**\*Other Options on Request**

Technical Parameters								
Model	Capacity	Nominal Pressure	Electric Motor		Connection	Temperature	Viscosity	Weight
			kW	RPM				
PV318M2MR	10 m <sup>3</sup> /h	4.0 bar	3.0	200	male union joints DIN 11851	+2 ÷ +85°C	up to 150 Pa.s	130 kg
PV315M2MR	20 m <sup>3</sup> /h		5.5					195 kg
PV316M2MR	30 m <sup>3</sup> /h		7.5					240 kg
PV317M2MR	40 m <sup>3</sup> /h		11.0					280 kg
PV319M2MR	50 m <sup>3</sup> /h		15.0	150				350 kg

Characteristic Curves of the Unitech Screw Pumps Series 310  
Model PV318

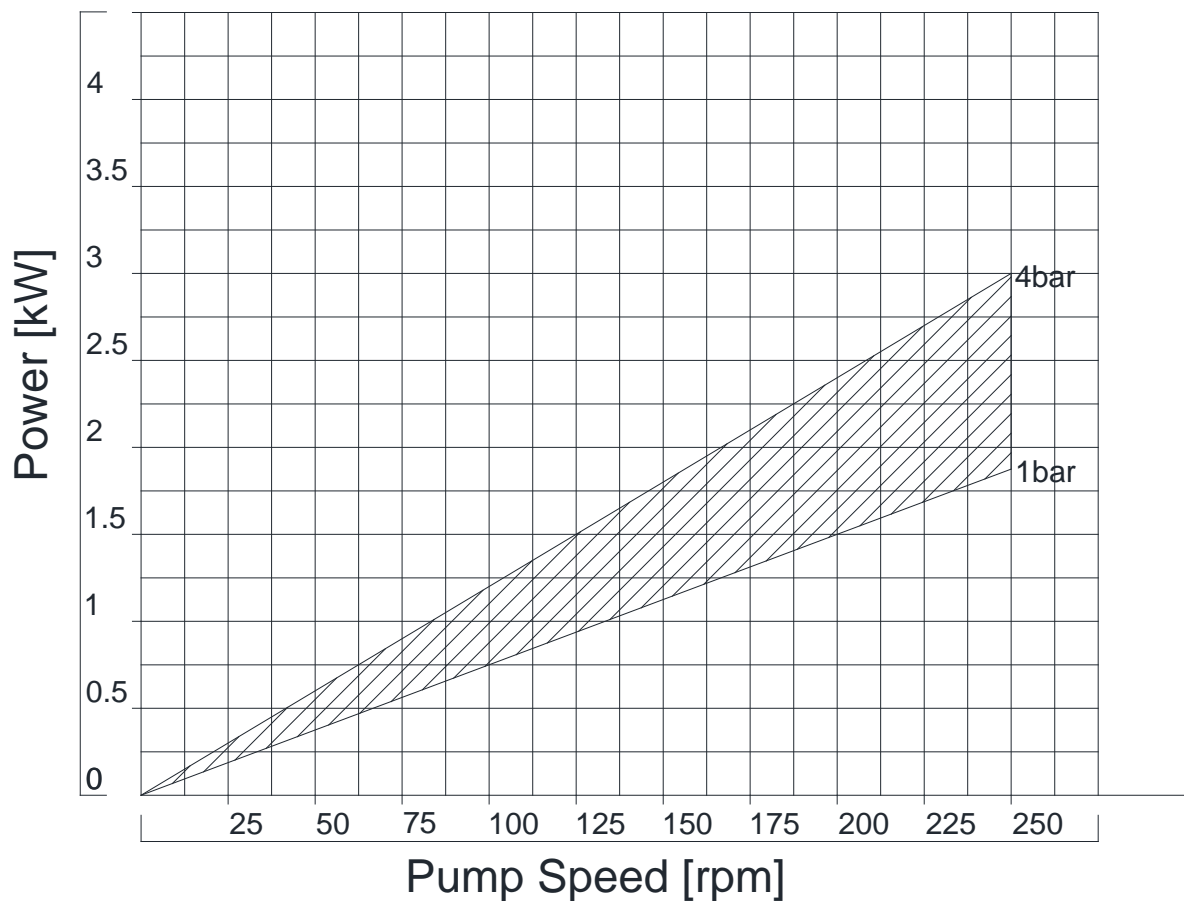
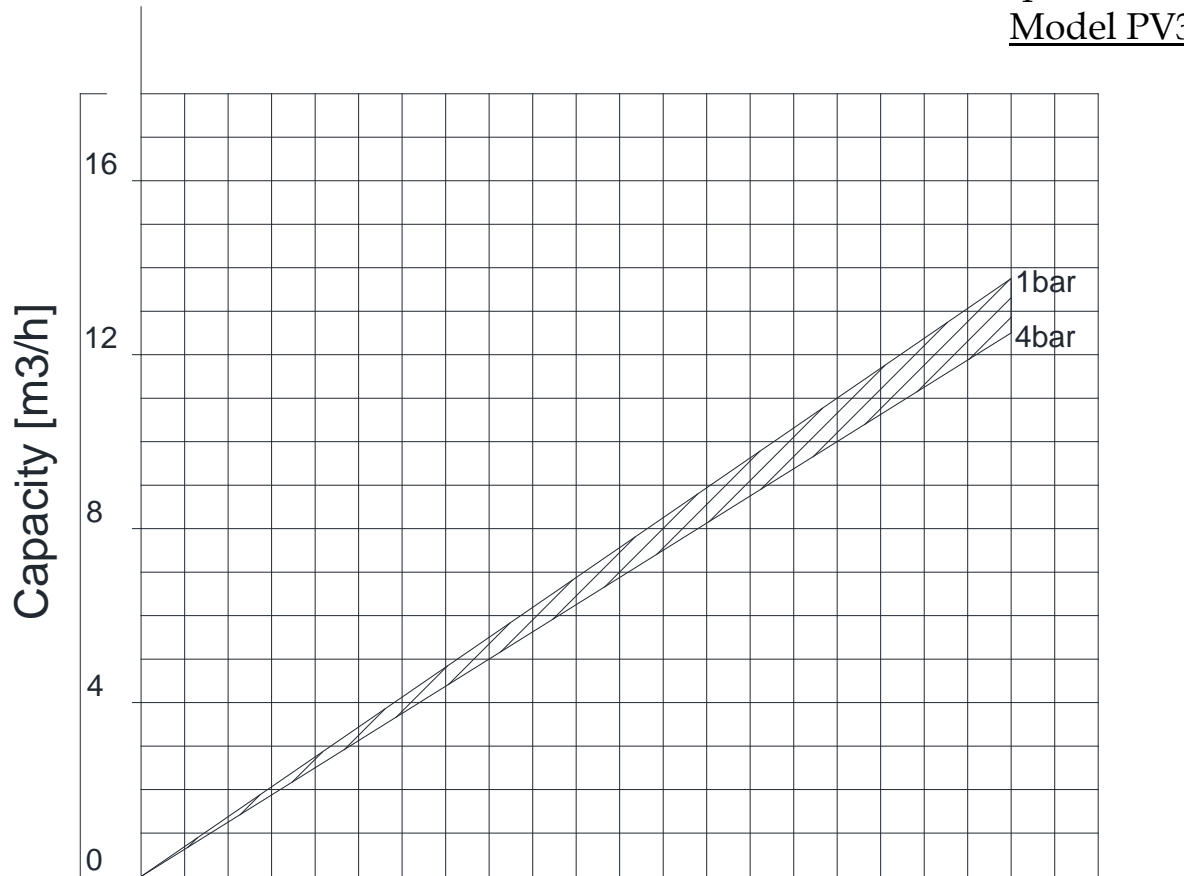

\*with fluid – water at temperature 20 °C.  
\*with pipes equal with pump's connections.

Characteristic Curves of the Unitech Screw Pumps Series 310  
Model PV315

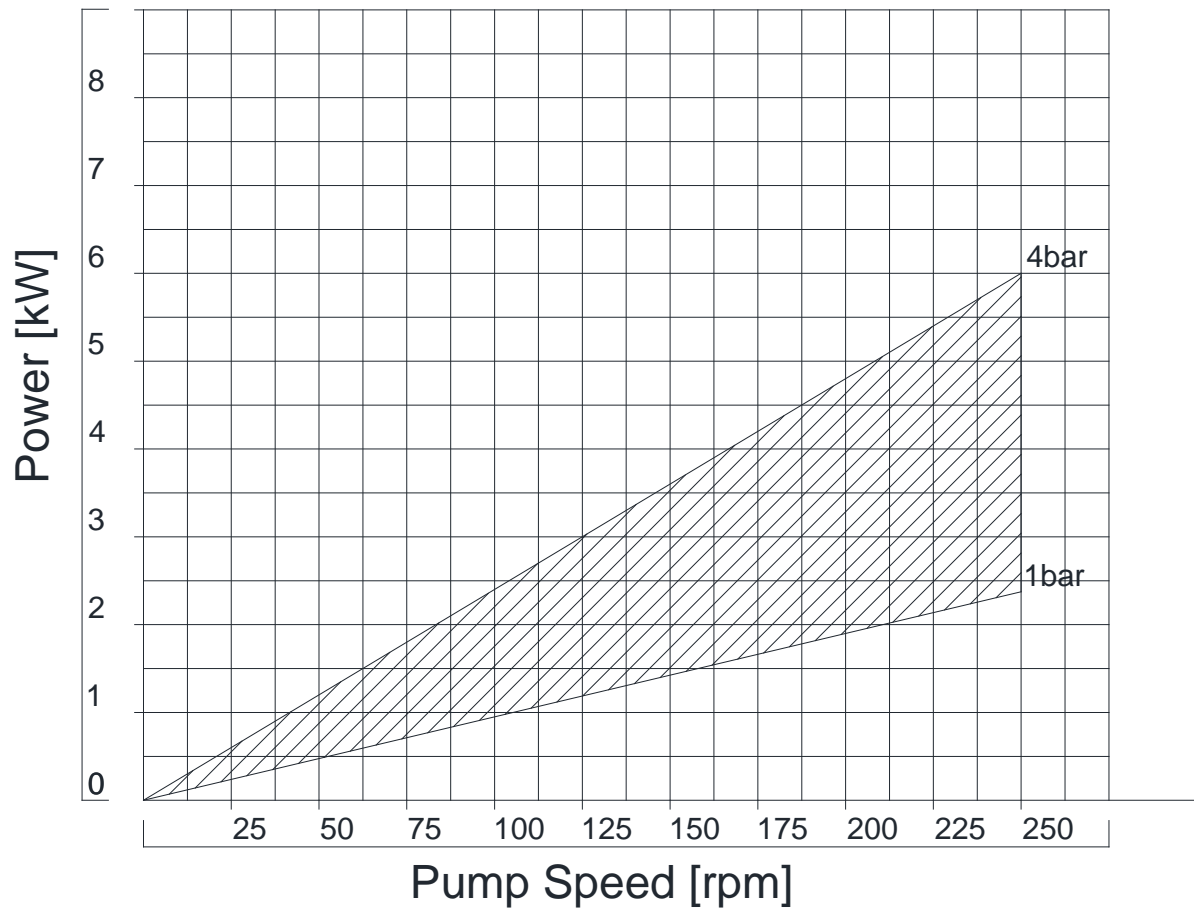
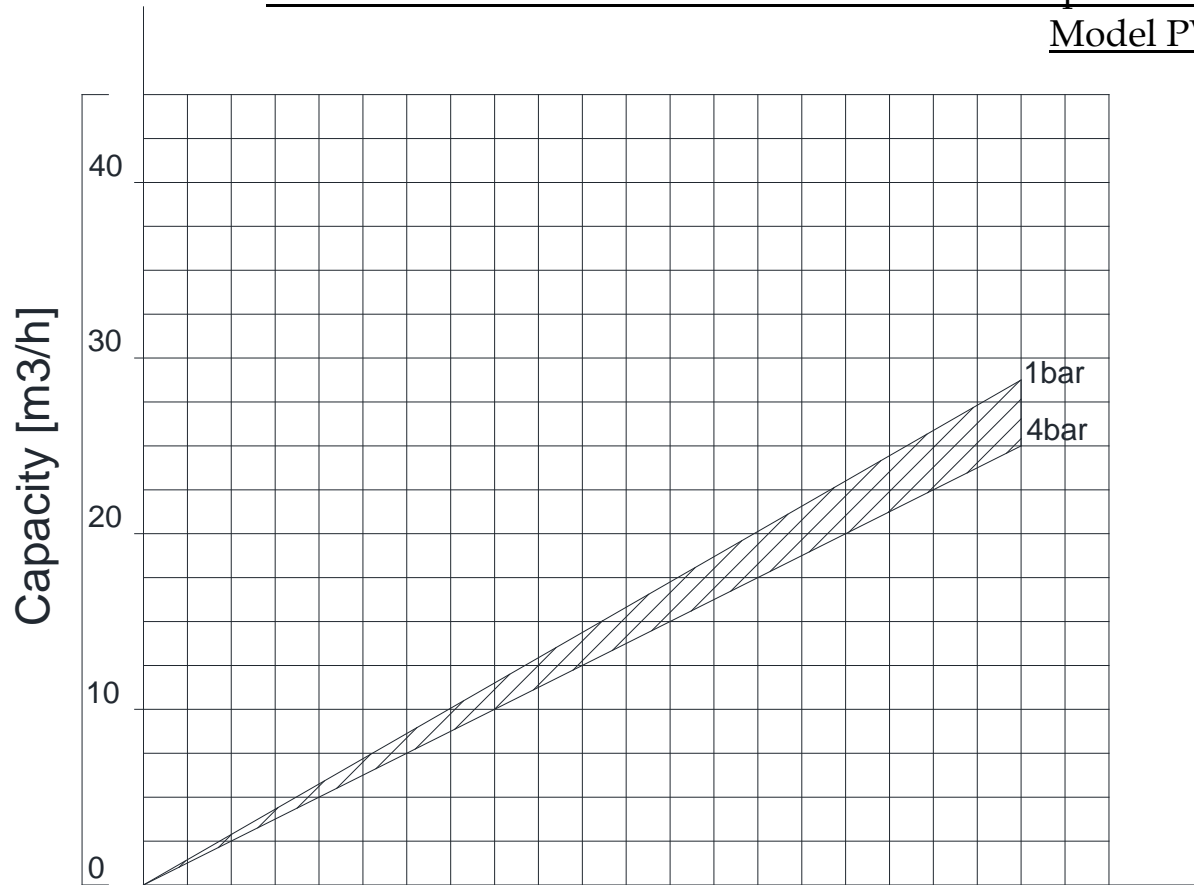

\*with fluid – water at temperature 20 °C.  
\*with pipes equal with pump's connections.

Characteristic Curves of the Unitech Screw Pumps Series 310  
Model PV316

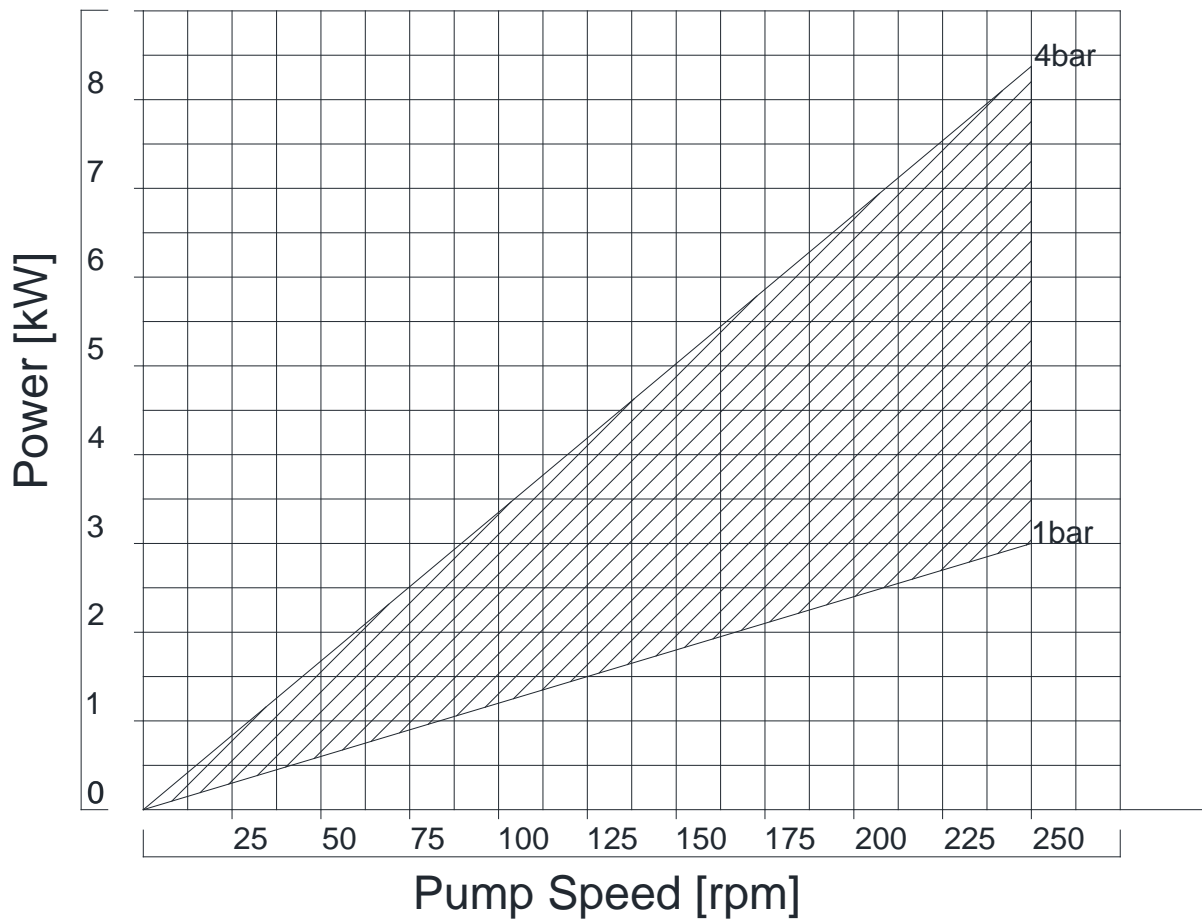
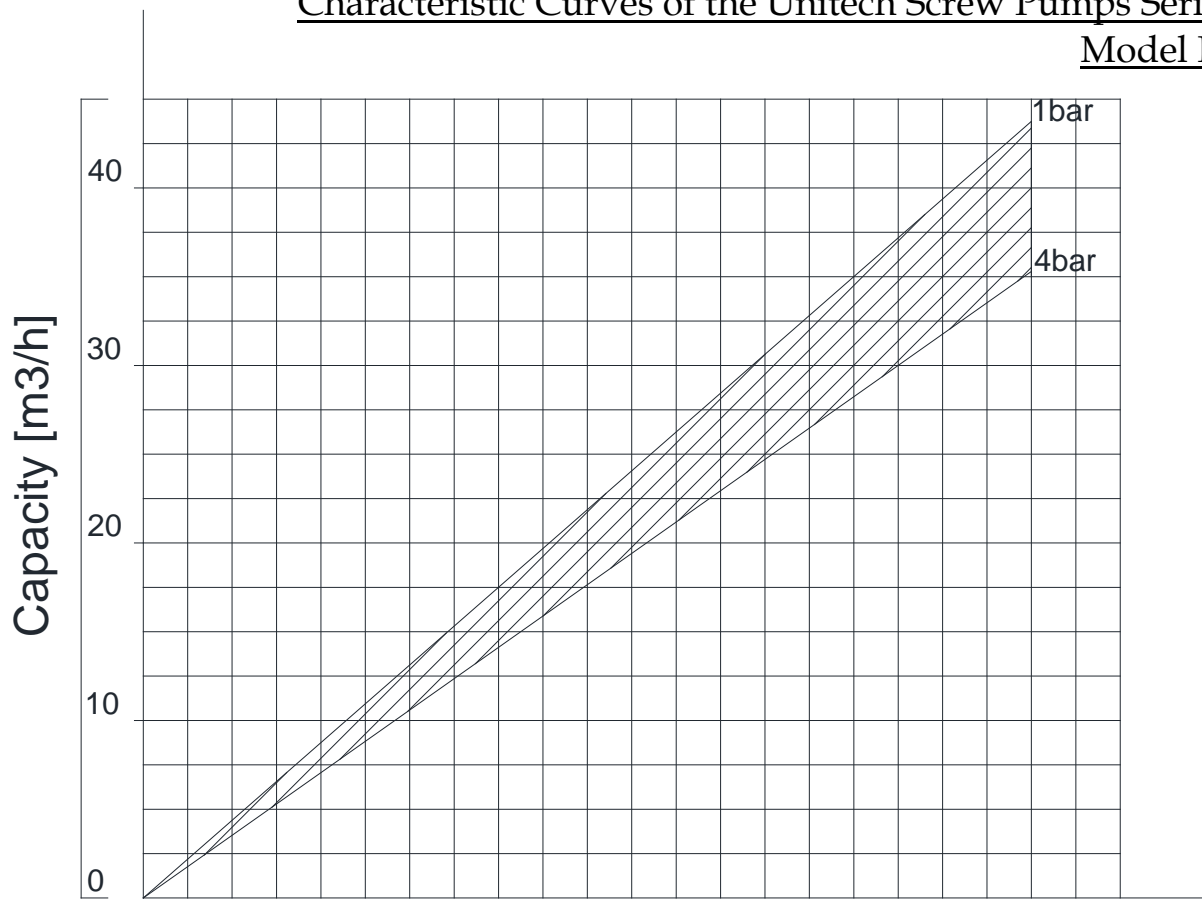

\*with fluid – water at temperature 20 °C.  
\*with pipes equal with pump's connections.

Characteristic Curves of the Unitech Screw Pumps Series 310  
Model PV317

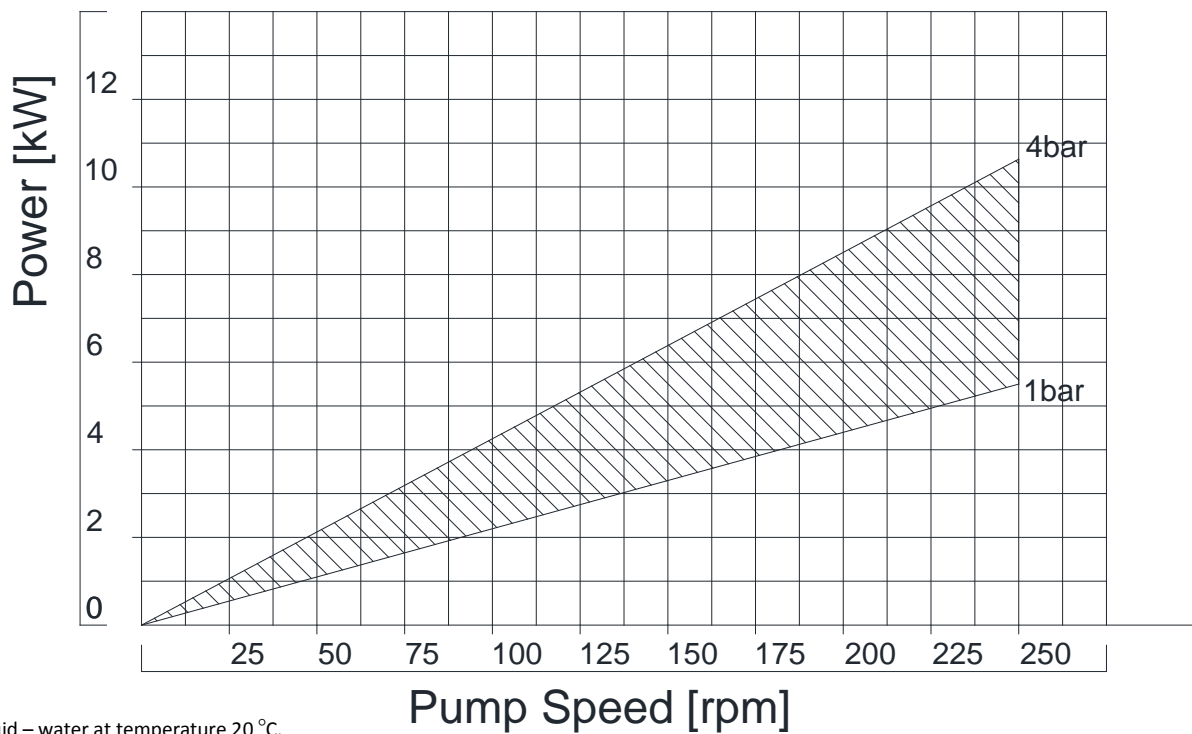
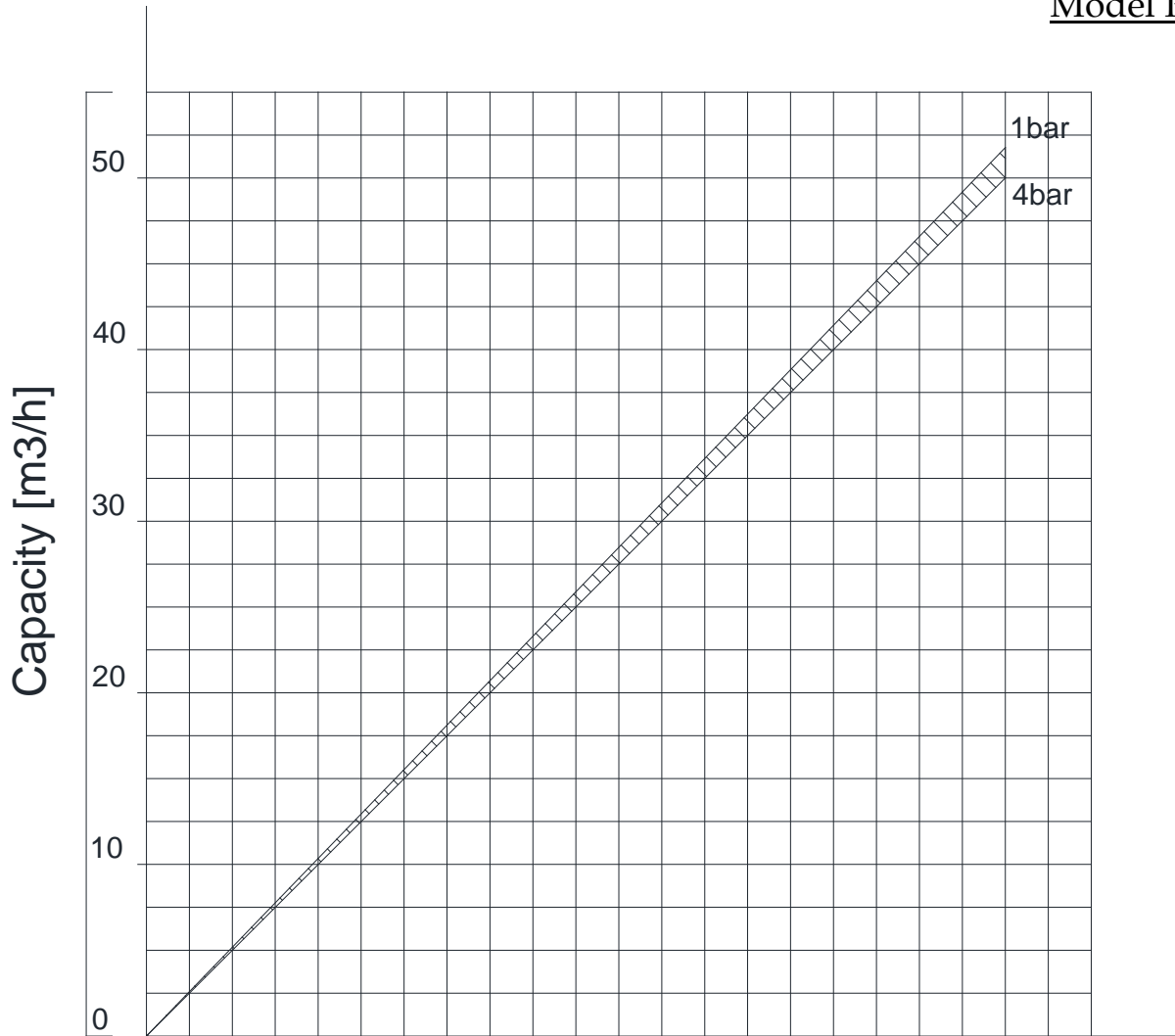

\*with fluid – water at temperature 20 °C.  
\*with pipes equal with pump's connections.

Characteristic Curves of the Unitech Screw Pumps Series 310  
Model PV319

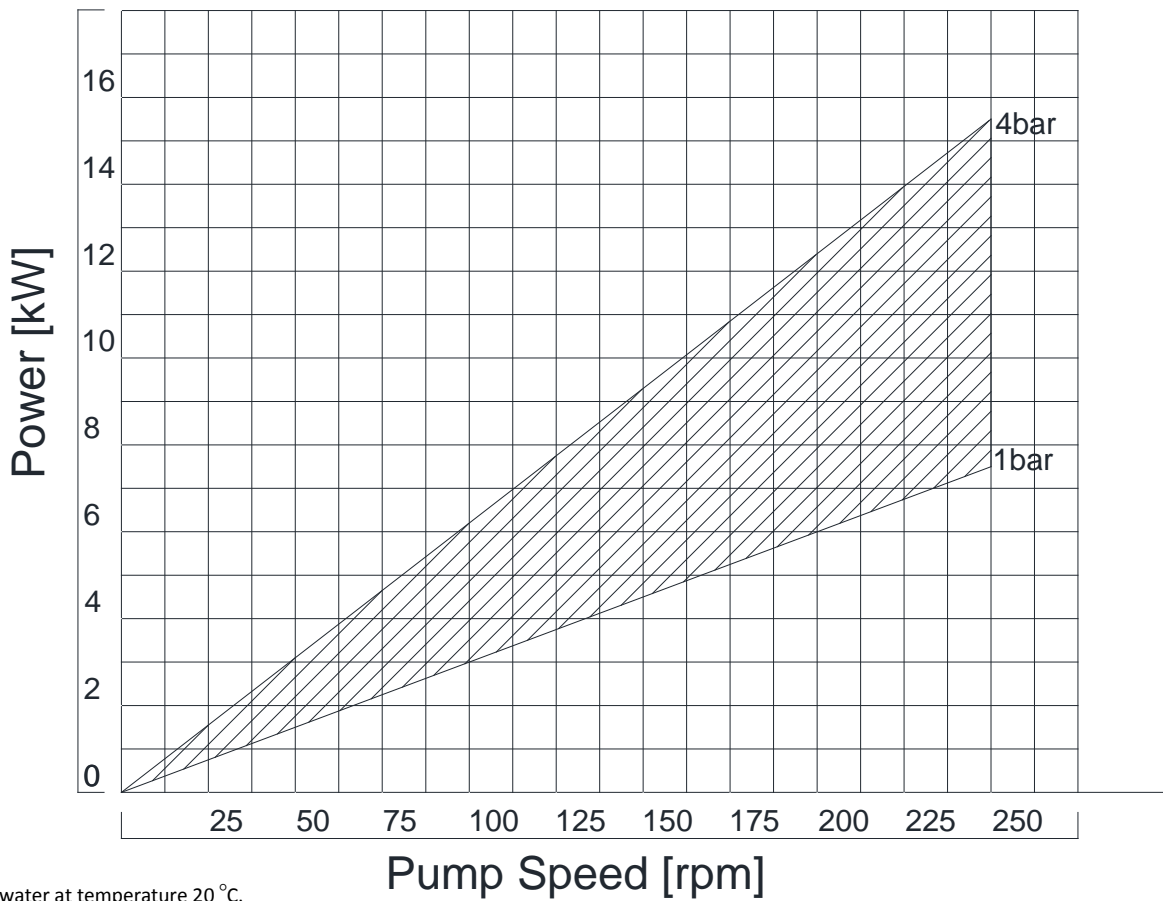
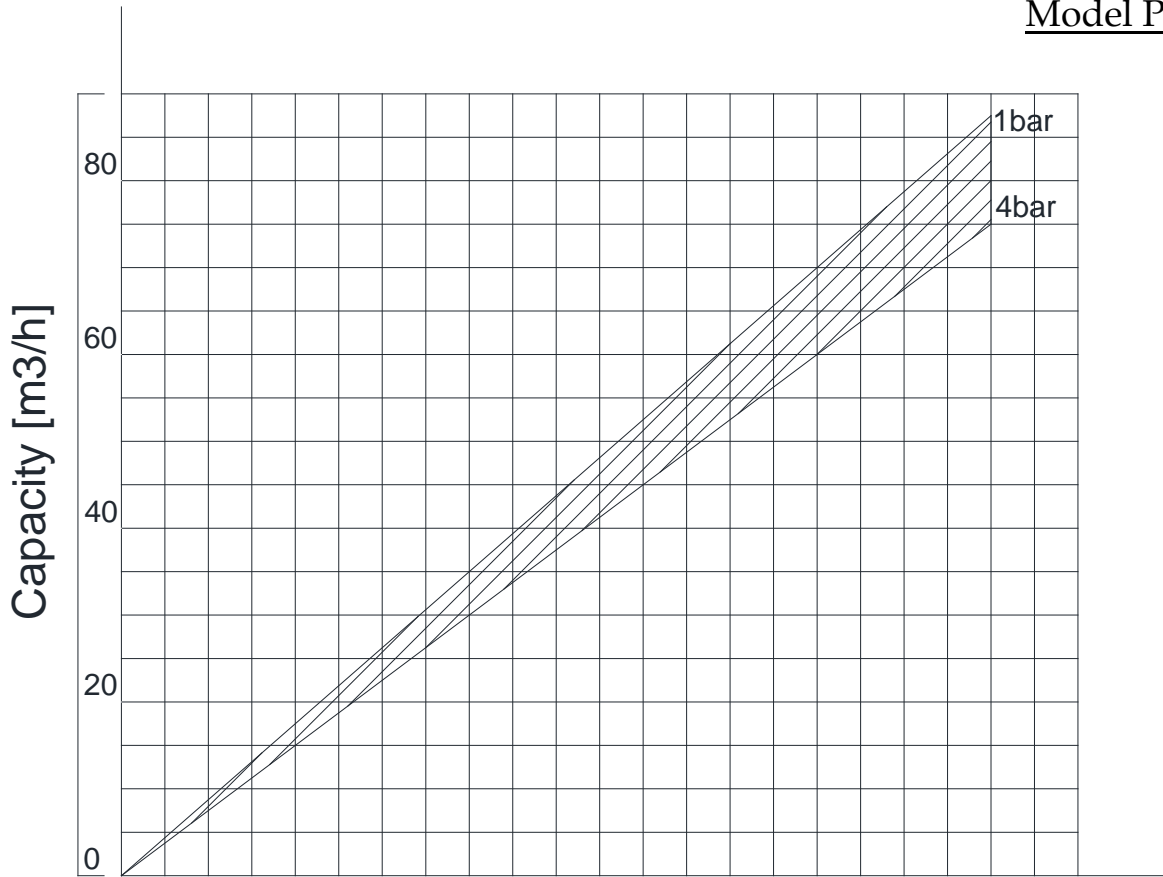

\*with fluid – water at temperature 20 °C.  
\*with pipes equal with pump's connections.

## Dimensions of the Unitech Screw Pumps Series 310 Models PV310M2MR

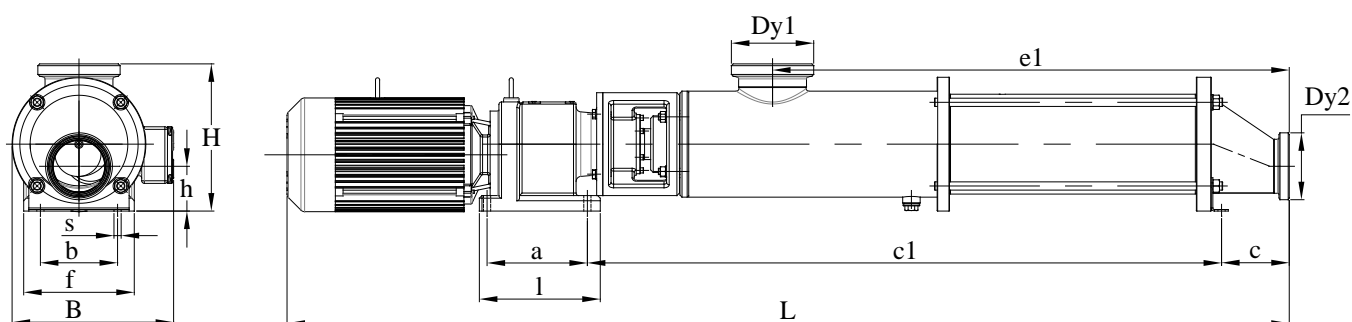

Dimensions, mm														
Model	Dy1	Dy2	L	B	H	h	e1	c	c1	a	b	f	l	s
PV318M2MR	100	80	1620	270	270	88	782	104	1039	165	135	190	200	13
PV315M2MR	100	100	1860	300	285	95	913	111	1163	195	150	215	235	14
PV316M2MR	125	100	1950	315	285	87	1005	131	1233	195	150	215	235	14
PV317M2MR	125	125	2115	375	295	96	1071	137	1320	205	170	230	245	17
PV319M2MR	125	125	2665	465	365	99	1570	145	1830	240	200	240	295	17